

Spring *Line*

Mod. **A8S . A8 . E5 . E5V**



COCCHI



Mod. A 8 S

Aspirante - Soffiante - Riscaldato
Vacuum - Blowing - Heated
Soufflante - Aspirante - Chauffée

Mod. A 8

Aspirante - Riscaldato
Vacuum - Heated
Aspirante - Chauffée

Linea - Spring

Mod. E 5

Aspirante - Riscaldato
Vacuum - Heated
Aspirante - Chauffée

Mod E 5 VS

Asp. Soffiante - Vaporizzante
Vac. Blowing - Steaming
Asp. Soufflante -

**SENZA CALDAIA
WITHOUT BOILER
SANS CHAUDIERE**

A8 S 1 - E5 1 - A8 1 - E5VS 1



Mod. E5 - E5VS - E5V

Piano Stiro - Ironing Board - Plateau Travail

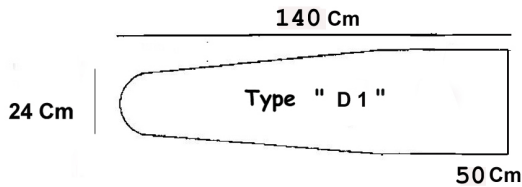

x Mod. A8 S - A8

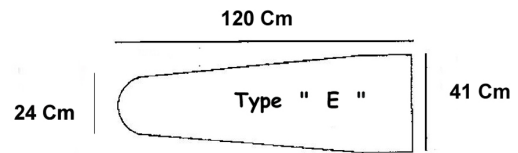

x Mod. E5 - E5 VS

Alluminio

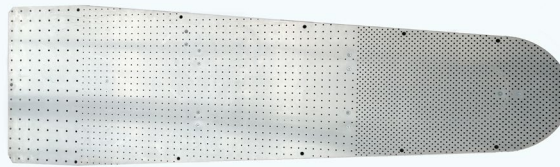

da 90 a 105 cm



TUTTO ALTO - ALL HIGH - TOUT HAUTE Cm 105



TUTTO BASSO - ALL LOW - TOUT BAS Cm 90

Descrip.	Mod.	A8 S	A8	E5	E5VS
Piano - Board - Plateau		Tipo D1	Tipo D1	Tipo E	Tipo E
Resistenza Piano - Board Element - Resistance Plateau		1000 watt	1000 watt	1000 watt	1000 watt
CALDAIA - BOILER - CHAUDIERE in INOX		5 + 0.5 Lts	5+0.5 Lts	5+0.5 Lts	5+2 Lts
RESISTENZE CALDAIA BOILER ELEMENTS RESISTANCES CHAUDIERE		3600 watt 4700 watt	3600 watt 4700 watt	2600 watt 3600 watt	4700 watt 6000 watt
MOTORE ASPIRAZIONE - VACUUM MOTOR - MOT. ASPIRATION		no	0,5 Hp	0,5 Hp	no
MOTORE ASPIRAZIONE - SOFFIATURA VACUUM-BLOWING MOTOR MOTEUR ASPIRATION-SOUFFLERIE		0,5 Hp plus	no	no	0,5 Hp plus
FERRO STIRO - IRON - FER A REPASSER		Incl. (H1)*	Incl.Jolly	Incl.Jolly	Incl.Jolly
RESISTENZA FERRO STIRO - IRON ELEMENT - RES. FER		900 watt	800 watt	800 watt	800 watt
POMPA ACQUA - WATER PUMP - POMPE A EAU		0,3 Hp	0,3 Hp	0,3 Hp	0,3 Hp
TANICA ACQUA - WATER TANK - BIDON POUR L'EAU		opt.	opt.	serie	no
FOTOCELLULA PER ASPIRAZIONE PHOTOCELL FOR VACUUM PHOTOCELLULE POUR ASPIRATION		serie	opt.	opt.	no
DOPPI PEDALI PER STIRATURA DESTRA-SINISTRA DOUBLE PEDALS FOR LEFT & RIGHT IRONING-SIDE DOUBLES PEDALS POUR REPASSAGE DROITE & GAUCHE		opt.	opt.	opt.	opt.
POGGIAFERRO ANTERIORE MOBILE IRON REST FRONTAL-MOBILE REPOSE FER ANTERIEUR MOBILE		serie	opt.	opt.	opt.
BRACCIOLA MANICHE SLEEVES-ARM JEANNETTE MANCHE		opt.	opt.	opt.	opt.
BRACCIOLA INOX SMACCHIATURA A VAPORE INOX ARM FOR STEAM-SPOTTING JEANNETTE INOX POUR DETACHAGE A VAPEUR		opt.	opt.	opt.	opt.
PISTOLA VAPORE - ARIA - PISTOLA VAPORE AIR-STEAM GUN - STEAM GUN PISTOLET AIR-VAPEUR - PISTOLET VAPEUR		opt.	opt.	opt.	opt.
BRACCIO LUCE o BRACCIO LUCE E SOSPENSIONE FERRO LIGHT ARM or LIGHT ARM & IRON-SUSPENSION BRAS ECLAIRAGE ou BRAS ECLAIRAGE ET SUSPENT-FER		opt.	opt.	opt.	opt.
FERRO VAPORE - VAPORE e / o RECUPERATORE Cond STEAM - STEAM IRON and / or CONDENS. RECUPER. FER VAPEUR - VAPEUR et / ou RECUPERATEUR Cond		opt. Kg 1,3	opt. Kg 1,3	opt. Kg 1,3	opt. Kg 1,3

*** SISTEMA VAPORIZZAZIONE AD INIEZIONE DIRETTA VAPORE
STEAMING-BOARD AT DIRECT INJECTIO OF STEAM
VAPORISSATION-PLATEAU A INJECTION DIRECTE DE VAPEUR



COCCHI srl

via Pacinotti 19-A - 40017 San Giovanni in Persiceto - Bologna - Italy

tel. ++39 - 051 821787 fax ++39 - 051 826935 web site : www.cocchi.net e.mail: info@cocchi.net



0,4 Lts

5 Lts



INOX 5 LTS + 0,4 LTS

PRESSIONE VAPORE 4 Bar
STEAM PRESSURE 4 Bar
PRESSION VAPEUR 4 Bar

H1 ERGONOMICO*



Kg 1,5 Elettrico - Electric 900 watt



Opt. A8 - A8S

Serie. E5

Tanica Acqua a Controllo
Elettronico del livello

Water Tank at electronic
control of the level

Bidon pour l'Eau à controle
electronique du niveau.

END-WATER LIGHT

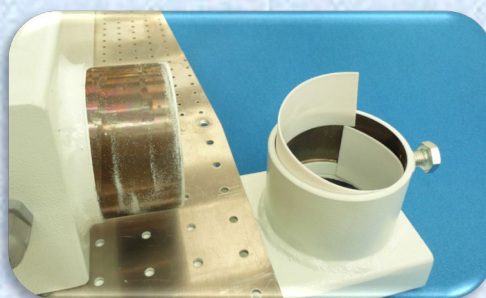

teflon anigrippaggio braccioli
teflon anti-seizure arms
teflon anti-grippage jeannettes

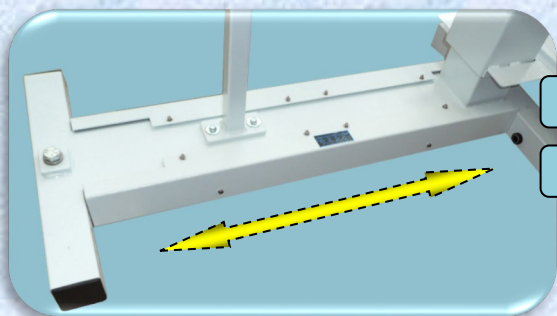

Opt. E5 - A8

Serie. A8S

Fotocellula - Photocell

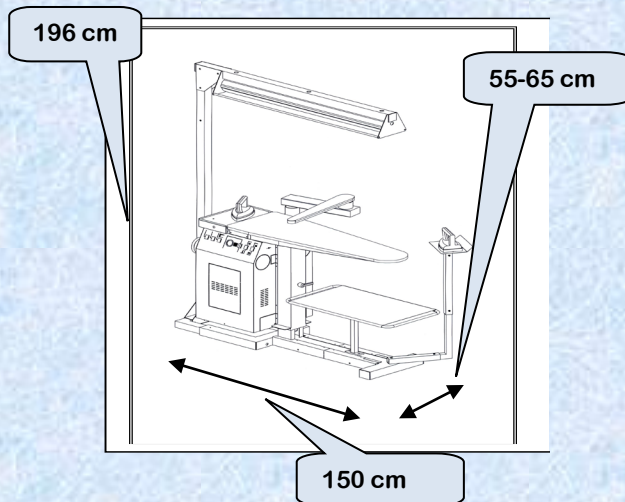

Serie. A8S . A8 Piano - Board - Plateau D1

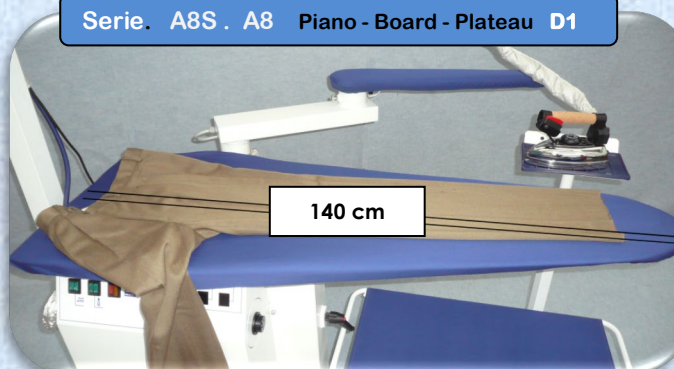

140 cm

Serie. E5 Piano - Board - Plateau E

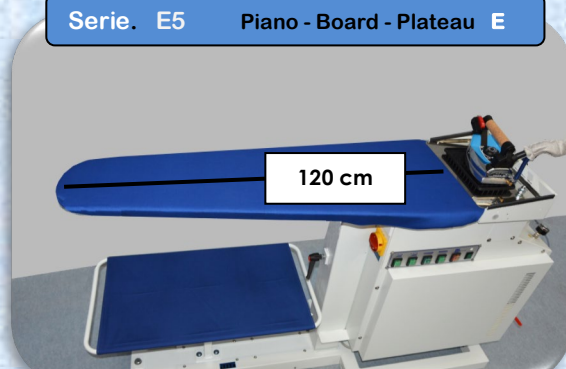

120 cm